

STANLEY®

CATALOGO DE SOLDADURA LATAM 2021



www.STANLEYTOOLS.com

STANLEY®

A STORY

BEHIND

EVERY

WELDING MACHINE

GB • Awelco is beyond 40 years engaged to supply to the customers a satisfactory ratio quality/price thanks to the innovation and the technological research. Think global, act local. The continuous testing, the resead in design and the constant widening of the range, realized by flexible Company structure, concur us to satisfy many and various customers requirements.

F • Awelco est engagé de plus de 40 ans à fournir aux clients un ratio satisfaisant qualité/prix grâce à l'innovation et à la recherche technologique. Penser globalement, agir localement. Les essais continus, la recherche et l'élargissement constant de la gamme, réalisé par une structure flexible de la société, nous permettent de répondre très rapidement aux diverses exigences de nos clients.

E • Awelco hace mas de 40 años que está comprometida con entregar a los clientes, una relación calidad/precio altamente satisfactoria debido a la innovación e investigación tecnologica. Pensar global pero actuar local. La experimentación, la proyección y la ampliación constante de la gama, realizada por una structura de empresa flexible, nos permiten satisfacer las más variadas exigencias de nuestros clientes.

PT • Awelco está comprometida há mais de 40 anos a fornecer aos clientes uma relação qualidade / preço altamente satisfatória devido à inovação e à pesquisa tecnológica. Pense global, mas aja localmente. A experimentação, a projeção e a constante expansão da gama, feita por uma estrutura flexível da empresa, permitem satisfazer as mais variadas exigências dos nossos clientes.





KEY TO SYMBOLS



GB • Fan
FR • Ventilateur
E • Ventilador
PT • Ventilador



GB • Single phase
FR • Monophasé
E • Monofásico
PT • Fase única



GB • Power generator connectable
FR • Connectable au groupe électrogène
E • Conectable al generador
PT • Conectável ao gerador



GB • Average temperature 20°
FR • Température moyenne 20°
E • Temperatura promedio 20°
PT • Temperatura média 20°



GB • Tig Lift function
FR • Tig Lift fonction
E • Función Tig Lift
PT • Função Tíg Lift



GB • Double fan
FR • Double ventilation
E • Doble ventilación
PT • Ventilador duplo



GB • Flex input voltage
FR • Tension d'entrée flexible
E • Voltaje de entrada flexible
PT • Tensão de entrada flexível



GB • Digital display
FR • Affichage numérique
E • Pantalla digital
PT • Display digital



GB • Gas/No gas
FR • Gaz/No gaz
E • Gas/No gas
PT • Gas/No gas



GB • Wire speed regulator
FR • Régulateur de la vitesse du fil
E • Regulador de velocidad de alambre
PT • Regulador de velocidade do fio



GB • Insulation Class
FR • Class d'isolation
E • Clase de aislamiento
PT • Classe de isolamento



GB • Protection degree
FR • Degré de protection
E • Grado de protección
PT • Grau de proteção



GB • Extension power cable
FR • Rallonge
E • Extensión del cable de alimentación
PT • Extensão do cabo de alimentação



GB • Direct Connection Torch
FR • Connexion Directe
E • Conexión Directa
PT • Conexão direta



GB • SPOOL GUN connector
FR • Connecteur SPOOL GUN
E • Conector SPOOL GUN
PT • Conector SPOOL GUN

GB • The manufacturer does not accept any responsibility for any typing or printing errors in this catalogue. It also reserves the right to make any alterations or modifications deemed necessary at any time, without altering or interfering with the basic functions of the apparatus.

FR • Le fabricant décline toute responsabilité pour les fautes de retranscription ou les erreurs d'impression dans ce catalogue. Elle se réserve également le droit d'apporter à tout moment des modifications ou des adaptations jugées nécessaires pour une amélioration du produit, sans altérer les fonctions de base de l'appareil.

E • El fabricante declina toda responsabilidad en relación a las eventuales inexactitudes contenidas en este catálogo debido a errores de imprenta o de transcripción. Se reserva también el derecho de aportar, sin aviso previo las variaciones que considere útiles y necesarias a fin de mejorar la calidad de sus productos, sin modificar por ello las características de utilización de los mismos.

PT • O fabricante declina toda a responsabilidade em relação às possíveis imprecisões contidas neste catálogo devido a erros de impressão ou transcrição. Também se reserva o direito de fornecer, sem aviso prévio, as variações que considera úteis e necessárias para melhorar a qualidade de seus produtos, sem modificar as características de seu uso.



MMA ARC WELDING

When two metals are joined with a filler metal then the fusion is obtained with an electric arc. The filler materials are electrodes or metal coated rods with material deoxidizer.

Lorsque deux métaux sont liés par un métal d'apport la fusion a lieu grâce a un arc électrique. Le matériau d'apport provient d'électrodes ou de tiges de métal revêtues de matériau désoxydant.

Al unir dos metales con un metal de relleno, la fusión se obtiene mediante un arco eléctrico. Los materiales de relleno son electrodos o varillas recubiertas de metal con desoxidante.

Ao unir dois metais com um metal de adição, a fusão é obtida por um arco elétrico. Os materiais de preenchimento são eletrodos ou hastes revestidas de metal com desoxidante.

INVERTER WELDING MACHINE

GB • Inverter technology welding machine, light, compact and reliable. Suitable for rutile electrodes.

F • Équipement de soudage avec technologie inverter. Léger, compact et fiable. Convient aux électrodes de rutile.

E • Equipo de soldadura con tecnología inverter. Ligero, compacto y confiable. Adecuado para electrodos de rutilio.

PT • Equipamento de soldagem com tecnologia inversora. Leve, compacto e confiável. Adequado para eletrodos rutilio.



• FR

- 1 Poignée avec un design ergonomique
- 2 Affichage numérique
- 3 Connecteurs Dinse pour des connexions de câbles de soudage de haute qualité
- 4 Corps en métal pour une durabilité accrue

• E

- 1 Poignée avec un design ergonomique
- 2 Affichage numérique
- 3 Conectores Dinse para conexiones de cables de soldadura de alta calidad
- 4 Cuerpo de metal para mayor durabilidad

• PT

- 1 Poignée com design ergonômico
- 2 Affichage numérique
- 3 Conectores Dinse para conexões de cabos de solda de alta qualidade
- 4 Corpo metálico para maior durabilidade



STAR 3200



TECHNICAL SPECIFICATIONS	
Main Voltage - Tension de réseau - Voltaje de red - Tensão de rede	230V, 50-60Hz
Absorbed Power - Puissance absorbée - Potencia absorbida - Potência absorvida	4,8 kVA - 3,5kW
No load Voltage - Tension à vide - Tensión en vacío - Tensão de vácuo	66V
Welding Current - Courant de soudage - Corriente de soldadura - Corrente de soldagem	20-120A 130MAX
Duty Cycle - Cycle de service - Ciclo de trabajo - Ciclo de Trabalho - EN 60974-1	120A 20%
Duty Cycle - Cycle de service - Ciclo de trabalho - Ciclo de Trabalho - 20° C Normal Use	130A@40%
Min-Max Electrode - Electrode Min-Max - Electrodo min-max - Electrodo min-max	1,6-3,2mm
Box volume - Volume carton - Volumen caja - Volume em dinheiro	0,012m ³
Box Size - Dimensions du carton - Cartón dimensiones - Dimensões de papelão	180x335x195mm
Box Weight - Poids de la boîte - Peso de la caja - Peso da caixa	3,4Kg
PCS per Masterbox - PCS par Masterbox - PCS por Masterbox - PCS por Masterbox	1 PCS
PCS per Euro Pallet - PCS par Euro Pallet - PCS por Euro Pallet - PCS por Euro Pallet	112 PCS
Code - Code - Código - Code	61316
Bar Code - Code barre - Código barra - Code à barres	8004386613160

Made in P.R.C



STAR 4000



TECHNICAL SPECIFICATIONS	
Main Voltage - Tension de réseau - Voltaje de red - Tensão de rede	230V, 50-60Hz
Absorbed Power - Puissance absorbée - Potencia absorbida - Potência absorvida	5,6 kVA - 4,1kW
No load Voltage - Tension à vide - Tensión en vacío - Tensão de vácuo	66V
Welding Current - Courant de soudage - Corriente de soldadura - Corrente de soldagem	25-140A 160MAX
Duty Cycle - Cycle de service - Ciclo de trabajo - Ciclo de Trabalho - EN 60974-1	140A 20%
Duty Cycle - Cycle de service - Ciclo de trabalho - Ciclo de Trabalho - 20° C Normal Use	160A@40%
Min-Max Electrode - Electrode Min-Max - Electrodo min-max - Electrodo min-max	1,6-4,0mm
Box volume - Volume carton - Volumen caja - Volume em dinheiro	0,012m ³
Box Size - Dimensions du carton - Cartón dimensiones - Dimensões de papelão	180x335x195mm
Box Weight - Poids de la boîte - Peso de la caja - Peso da caixa	3,7Kg
PCS per Masterbox - PCS par Masterbox - PCS por Masterbox - PCS por Masterbox	1 PCS
PCS per Euro Pallet - PCS par Euro Pallet - PCS por Euro Pallet - PCS por Euro Pallet	112 PCS
Code - Code - Código - Code	61425
Bar Code - Code barre - Código barra - Code à barres	8004386614259

Made in P.R.C



STAR 7000



TECHNICAL SPECIFICATIONS	
Main Voltage - Tension de réseau - Voltaje de red - Tensão de rede	230V, 50-60Hz
Absorbed Power - Puissance absorbée - Potencia absorbida - Potência absorvida	6,5 kVA - 4,9kW
No load Voltage - Tension à vide - Tensión en vacío - Tensão de vácuo	66V
Welding Current - Courant de soudage - Corriente de soldadura - Corrente de soldagem	30-160A 190MAX
Duty Cycle - Cycle de service - Ciclo de trabajo - Ciclo de Trabalho - EN 60974-1	160A 20%
Duty Cycle - Cycle de service - Ciclo de trabalho - Ciclo de Trabalho - 20° C Normal Use	190A@40%
Min-Max Electrode - Electrode Min-Max - Electrodo min-max - Electrodo min-max	1,6-5,0mm
Box volume - Volume carton - Volumen caja - Volume em dinheiro	0,012m ³
Box Size - Dimensions du carton - Cartón dimensiones - Dimensões de papelão	180x335x195mm
Box Weight - Poids de la boîte - Peso de la caja - Peso da caixa	4,1Kg
PCS per Masterbox - PCS par Masterbox - PCS por Masterbox - PCS por Masterbox	1 PCS
PCS per Euro Pallet - PCS par Euro Pallet - PCS por Euro Pallet - PCS por Euro Pallet	112 PCS
Code - Code - Código - Code	61720
Bar Code - Code barre - Código barra - Code à barres	8004386617205

Made in P.R.C



INVERTER WELDING MACHINE

GB • Inverter technology welding machine, light, compact and reliable. Suitable for rutile electrodes.

F • Équipement de soudage avec technologie inverter. Léger, compact et fiable. Convient aux électrodes de rutile.

E • Equipo de soldadura con tecnología inverter. Ligero, compacto y confiable. Adecuado para electrodos de rutilio.

PT • Equipamento de soldagem com tecnologia inversora. Leve, compacto e confiável. Adequado para eletrodos rutilio.



• FR

- 1 Poignée avec un design ergonomique
- 2 Affichage numérique
- 3 Connecteurs Dinse pour des connexions de câbles de soudage de haute qualité
- 4 Corps en métal pour une durabilité accrue

• E

- 1 Poignée avec un design ergonomique
- 2 Affichage numérique
- 3 Conectores Dinse para conexiones de cables de soldadura de alta calidad
- 4 Cuerpo de metal para mayor durabilidad

• PT

- 1 Poignée com design ergonômico
- 2 Affichage numérique
- 3 Conectores Dinse para conexões de cabos de solda de alta qualidade
- 4 Corpo metálico para maior durabilidade



WD-A150IW1



TECHNICAL SPECIFICATIONS	
Main Voltage - Tension de réseau - Voltaje de red - Tensão de rede	230V, 50-60Hz
Absorbed Power - Puissance absorbée - Potencia absorbida - Potência absorvida	4 kVA - MAX
No load Voltage - Tension à vide - Tensión en vacío - Tensão de vácuo	60V
Welding Current - Courant de soudage - Corriente de soldadura - Corrente de soldagem	30-100A 130MAX
Duty Cycle - Cycle de service - Ciclo de trabajo - Ciclo de Trabalho - EN 60974-1	100A 10%
Duty Cycle - Cycle de service - Ciclo de trabajo - Ciclo de Trabalho - 20° C Normal Use	100A@20%
Min-Max Electrode - Electrode Min-Max - Electrodo min-max - Electrodo min-max	1,6-2,5(3,2)mm
Box volume - Volume carton - Volumen caja - Volume em dinheiro	0,017m ³
Box Size - Dimensions du carton - Cartón dimensiones - Dimensões de papelão	345x220x230mm
Box Weight - Poids de la boîte - Peso de la caja - Peso da caixa	4,8Kg
PCS per Masterbox - PCS par Masterbox - PCS por Masterbox - PCS por Masterbox	1 PCS
PCS per Euro Pallet - PCS par Euro Pallet - PCS por Euro Pallet - PCS por Euro Pallet	80 PCS
Code - Code - Código - Code	51005
Bar Code - Code barre - Código barra - Code à barres	8004386510056

Made in P.R.C

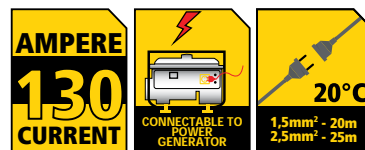

WD-A160IW1

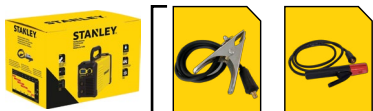

TECHNICAL SPECIFICATIONS	
Main Voltage - Tension de réseau - Voltaje de red - Tensão de rede	230V, 50-60Hz
Absorbed Power - Puissance absorbée - Potencia absorbida - Potência absorvida	6 kVA - MAX
No load Voltage - Tension à vide - Tensión en vacío - Tensão de vácuo	60V
Welding Current - Courant de soudage - Corriente de soldadura - Corrente de soldagem	30-140A 160MAX
Duty Cycle - Cycle de service - Ciclo de trabajo - Ciclo de Trabalho - EN 60974-1	140A 10%
Duty Cycle - Cycle de service - Ciclo de trabajo - Ciclo de Trabalho - 20° C Normal Use	140A@20%
Min-Max Electrode - Electrode Min-Max - Electrodo min-max - Electrodo min-max	1,6-3,2mm
Box volume - Volume carton - Volumen caja - Volume em dinheiro	0,017m ³
Box Size - Dimensions du carton - Cartón dimensiones - Dimensões de papelão	345x220x230mm
Box Weight - Poids de la boîte - Peso de la caja - Peso da caixa	5,1Kg
PCS per Masterbox - PCS par Masterbox - PCS por Masterbox - PCS por Masterbox	1 PCS
PCS per Euro Pallet - PCS par Euro Pallet - PCS por Euro Pallet - PCS por Euro Pallet	80 PCS
Code - Code - Código - Code	51045
Bar Code - Code barre - Código barra - Code à barres	8004386510452

Made in P.R.C

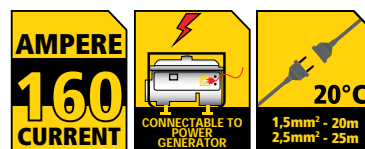

WD-A200IW1

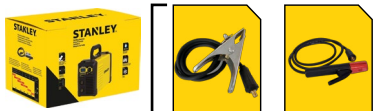

TECHNICAL SPECIFICATIONS	
Main Voltage - Tension de réseau - Voltaje de red - Tensão de rede	230V, 50-60Hz
Absorbed Power - Puissance absorbée - Potencia absorbida - Potência absorvida	7 kVA - MAX
No load Voltage - Tension à vide - Tensión en vacío - Tensão de vácuo	60V
Welding Current - Courant de soudage - Corriente de soldadura - Corrente de soldagem	30-160A 190MAX
Duty Cycle - Cycle de service - Ciclo de trabajo - Ciclo de Trabalho - EN 60974-1	160A 10%
Duty Cycle - Cycle de service - Ciclo de trabajo - Ciclo de Trabalho - 20° C Normal Use	160A@20%
Min-Max Electrode - Electrode Min-Max - Electrodo min-max - Electrodo min-max	1,6-4,0mm
Box volume - Volume carton - Volumen caja - Volume em dinheiro	0,017m ³
Box Size - Dimensions du carton - Cartón dimensiones - Dimensões de papelão	345x220x230mm
Box Weight - Poids de la boîte - Peso de la caja - Peso da caixa	5,4Kg
PCS per Masterbox - PCS par Masterbox - PCS por Masterbox - PCS por Masterbox	1 PCS
PCS per Euro Pallet - PCS par Euro Pallet - PCS por Euro Pallet - PCS por Euro Pallet	80 PCS
Code - Code - Código - Code	51065
Bar Code - Code barre - Código barra - Code à barres	8004386510650

Made in P.R.C

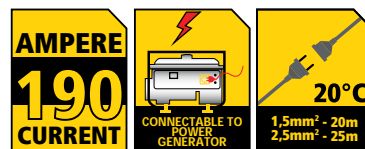

INVERTER WELDING MACHINE

GB • Inverter technology welding machine, light, compact and reliable. Suitable for rutile electrodes.

F • Équipement de soudage avec technologie inverter. Léger, compact et fiable. Convient aux électrodes de rutile.

E • Equipo de soldadura con tecnología inverter. Ligero, compacto y confiable. Adecuado para electrodos de rutilio.

PT • Equipamento de soldagem com tecnologia inversora. Leve, compacto e confiável. Adequado para eletrodos rutilo.



- FR
- 1 Poignée avec un design ergonomique
- 2 Affichage numérique
- 3 Connecteurs Dinse pour des connexions de câbles de soudage de haute qualité
- 4 Corps en métal pour une durabilité accrue

- E
- 1 Poignée avec un design ergonomique
- 2 Affichage numérique
- 3 Conectores Dinse para conexiones de cables de soldadura de alta calidad
- 4 Cuerpo de metal para mayor durabilidad

- PT
- 1 Poignée com design ergonômico
- 2 Affichage numérique
- 3 Conectores Dinse para conexões de cabos de solda de alta qualidade
- 4 Corpo metálico para maior durabilidade



SIRIO 140



TECHNICAL SPECIFICATIONS	
Main Voltage - Tension de réseau - Voltaje de red - Tensão de rede	230V, 50-60Hz
Absorbed Power - Puissance absorbée - Potencia absorbida - Potência absorvida	5,6 kVA - 4,1kW
No load Voltage - Tension à vide - Tensión en vacío - Tensão de vácuo	60V
Welding Current - Courant de soudage - Corriente de soldadura - Corrente de soldagem	30-130A
Duty Cycle - Cycle de service - Ciclo de trabajo - Ciclo de Trabalho - EN 60974-1	130A 10%
Duty Cycle - Cycle de service - Ciclo de trabajo - Ciclo de Trabalho - 20° C Normal Use	130A@30%
Min-Max Electrode - Electrode Min-Max - Electrodo min-max - Electrodo min-max	1,6-3,25mm
Box volume - Volume carton - Volumen caja - Volume em dinheiro	0,029m ³
Box Size - Dimensions du carton - Cartón dimensiones - Dimensões de papelão	410x200x350mm
Box Weight - Poids de la boîte - Peso de la caja - Peso da caixa	4,7Kg
PCS per Masterbox - PCS par Masterbox - PCS por Masterbox - PCS por Masterbox	4 PCS
PCS per Euro Pallet - PCS par Euro Pallet - PCS por Euro Pallet - PCS por Euro Pallet	48 PCS
Code - Code - Código - Code	61338
Bar Code - Code barre - Código barra - Code à barres	8004386613382

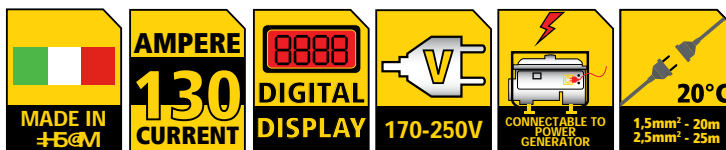

SIRIO 170

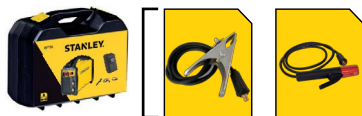

TECHNICAL SPECIFICATIONS	
Main Voltage - Tension de réseau - Voltaje de red - Tensão de rede	230V, 50-60Hz
Absorbed Power - Puissance absorbée - Potencia absorbida - Potência absorvida	5,8 kVA - 4,3kW
No load Voltage - Tension à vide - Tensión en vacío - Tensão de vácuo	60V
Welding Current - Courant de soudage - Corriente de soldadura - Corrente de soldagem	30-140A
Duty Cycle - Cycle de service - Ciclo de trabajo - Ciclo de Trabalho - EN 60974-1	140A 10%
Duty Cycle - Cycle de service - Ciclo de trabajo - Ciclo de Trabalho - 20° C Normal Use	160A@30%
Min-Max Electrode - Electrode Min-Max - Electrodo min-max - Electrodo min-max	1,6-4,0mm
Box volume - Volume carton - Volumen caja - Volume em dinheiro	0,029m ³
Box Size - Dimensions du carton - Cartón dimensiones - Dimensões de papelão	410x200x350mm
Box Weight - Poids de la boîte - Peso de la caja - Peso da caixa	4,8Kg
PCS per Masterbox - PCS par Masterbox - PCS por Masterbox - PCS por Masterbox	4 PCS
PCS per Euro Pallet - PCS par Euro Pallet - PCS por Euro Pallet - PCS por Euro Pallet	48 PCS
Code - Code - Código - Code	61457
Bar Code - Code barre - Código barra - Code à barres	8004386614570

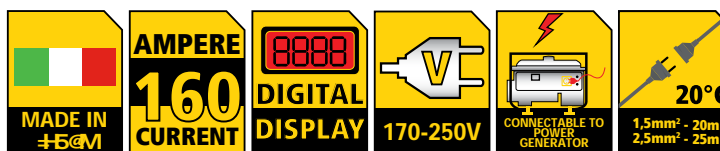

SIRIO 210

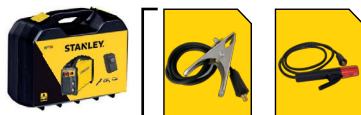

TECHNICAL SPECIFICATIONS	
Main Voltage - Tension de réseau - Voltaje de red - Tensão de rede	230V, 50-60Hz
Absorbed Power - Puissance absorbée - Potencia absorbida - Potência absorvida	6,7 kVA - 5,0kW
No load Voltage - Tension à vide - Tensión en vacío - Tensão de vácuo	60V
Welding Current - Courant de soudage - Corriente de soldadura - Corrente de soldagem	30-160A
Duty Cycle - Cycle de service - Ciclo de trabajo - Ciclo de Trabalho - EN 60974-1	190A 10%
Duty Cycle - Cycle de service - Ciclo de trabajo - Ciclo de Trabalho - 20° C Normal Use	190A@30%
Min-Max Electrode - Electrode Min-Max - Electrodo min-max - Electrodo min-max	1,6-4(5)mm
Box volume - Volume carton - Volumen caja - Volume em dinheiro	0,029m ³
Box Size - Dimensions du carton - Cartón dimensiones - Dimensões de papelão	410x200x350mm
Box Weight - Poids de la boîte - Peso de la caja - Peso da caixa	5,3Kg
PCS per Masterbox - PCS par Masterbox - PCS por Masterbox - PCS por Masterbox	4 PCS
PCS per Euro Pallet - PCS par Euro Pallet - PCS por Euro Pallet - PCS por Euro Pallet	48 PCS
Code - Code - Código - Code	61469
Bar Code - Code barre - Código barra - Code à barres	8004386614693

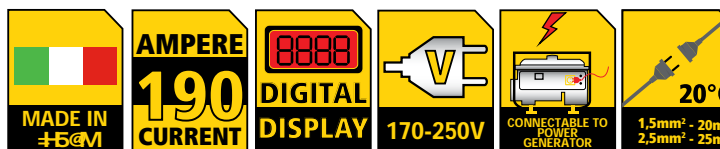

INVERTER WELDING MACHINE

THE BEST FOR YOUR JOB

LE MEILLEUR POUR VOTRE TRAVAIL

GB • Inverter technology welding machine, light, compact and reliable. Suitable for rutile electrodes.

F • Équipement de soudage avec technologie inverter. Léger, compact et fiable. Convient aux électrodes de rutile.

LO MEJOR PARA TU TRABAJO

E • Equipo de soldadura con tecnología inverter. Ligero, compacto y confiable. Adecuado para electrodos de rutilio.

PT • Equipamento de soldagem com tecnologia inversora. Leve, compacto e confiável. Adequado para eletrodos rutilio.

O MELHOR PARA SEU TRABALHO



• FR

- 1 Bracelet haute résistance
- 2 Bouton de réglage
- 3 Indicateur de surchauffe
- 4 Connecteurs Dinse pour des connexions de câbles de soudage de haute qualité
- 5 Corps en métal pour une durabilité accrue

• E

- 1 Correa de alta resistencia
- 2 Perilla de regulación
- 3 Indicador de sobrecalentamiento
- 4 Conectores Dinse para conexiones de cables de soldadura de alta calidad
- 5 Cuerpo de metal para mayor durabilidad

• PT

- 1 Alça de alta resistência
- 2 Botão de regulação
- 3 Indicador de superaquecimento
- 4 Conectores Dinse para conexões de cabos de solda de alta qualidade
- 5 Corpo metálico para maior durabilidade



WD130IC1



TECHNICAL SPECIFICATIONS	
Main Voltage - Tension de réseau - Voltaje de red - Tensão de rede	230V, 50-60Hz
Absorbed Power - Puissance absorbée - Potencia absorbida - Potência absorvida	5,5 kVA - MAX 3,0 kVA - 60%
No load Voltage - Tension à vide - Tensión en vacío - Tensão de vácuo	60V
Welding Current - Courant de soudage - Corriente de soldadura - Corrente de soldagem	10-130A
Duty Cycle - Cycle de service - Ciclo de trabajo - Ciclo de Trabalho - EN 60974-1	130A 15%
Duty Cycle - Cycle de service - Ciclo de trabajo - Ciclo de Trabalho - 20° C Normal Use	130A@60%
Min-Max Electrode - Electrode Min-Max - Electrodo min-max - Electrodo min-max	1,6-3,2mm
Box volume - Volume carton - Volumen caja - Volume em dinheiro	0,02m ³
Box Size - Dimensions du carton - Cartón dimensiones - Dimensões de papelão	370x160x300mm
Box Weight - Poids de la boîte - Peso de la caja - Peso da caixa	4,5Kg
PCS per Masterbox - PCS par Masterbox - PCS por Masterbox - PCS por Masterbox	1 PCS
PCS per Euro Pallet - PCS par Euro Pallet - PCS por Euro Pallet - PCS por Euro Pallet	72 PCS
Code - Code - Código - Code	61345
Bar Code - Code barre - Código barra - Code à barres	8004386613450

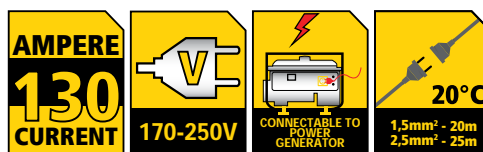

WD160IC1

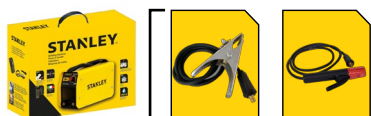

TECHNICAL SPECIFICATIONS	
Main Voltage - Tension de réseau - Voltaje de red - Tensão de rede	230V, 50-60Hz
Absorbed Power - Puissance absorbée - Potencia absorbida - Potência absorvida	7,0 kVA - MAX 4,0 kVA - 60%
No load Voltage - Tension à vide - Tensión en vacío - Tensão de vácuo	60V
Welding Current - Courant de soudage - Corriente de soldadura - Corrente de soldagem	10-160A
Duty Cycle - Cycle de service - Ciclo de trabajo - Ciclo de Trabalho - EN 60974-1	160A 20%
Duty Cycle - Cycle de service - Ciclo de trabajo - Ciclo de Trabalho - 20° C Normal Use	160A@60%
Min-Max Electrode - Electrode Min-Max - Electrodo min-max - Electrodo min-max	1,6-4,0mm
Box volume - Volume carton - Volumen caja - Volume em dinheiro	0,02m ³
Box Size - Dimensions du carton - Cartón dimensiones - Dimensões de papelão	370x160x300mm
Box Weight - Poids de la boîte - Peso de la caja - Peso da caixa	4,9Kg
PCS per Masterbox - PCS par Masterbox - PCS por Masterbox - PCS por Masterbox	1 PCS
PCS per Euro Pallet - PCS par Euro Pallet - PCS por Euro Pallet - PCS por Euro Pallet	72 PCS
Code - Code - Código - Code	61435
Bar Code - Code barre - Código barra - Code à barres	8004386614358

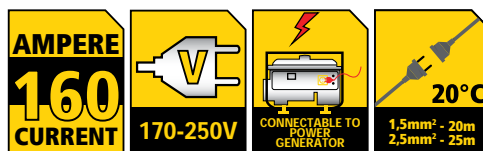

WD200IC2

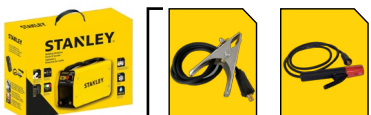

TECHNICAL SPECIFICATIONS	
Main Voltage - Tension de réseau - Voltaje de red - Tensão de rede	230V, 50-60Hz
Absorbed Power - Puissance absorbée - Potencia absorbida - Potência absorvida	8,5 kVA - MAX 5,0 kVA - 60%
No load Voltage - Tension à vide - Tensión en vacío - Tensão de vácuo	65V
Duty Cycle - Cycle de service - Ciclo de trabajo - Ciclo de Trabalho - EN 60974-1	15-200A 200A 20%
Duty Cycle - Cycle de service - Ciclo de trabajo - Ciclo de Trabalho - 20° C Normal Use	200A@60%
Min-Max Electrode - Electrode Min-Max - Electrodo min-max - Electrodo min-max	1,6-5,0mm
Box volume - Volume carton - Volumen caja - Volume em dinheiro	0,02m ³
Box Size - Dimensions du carton - Cartón dimensiones - Dimensões de papelão	370x160x300mm
Box Weight - Poids de la boîte - Peso de la caja - Peso da caixa	6,7Kg
PCS per Masterbox - PCS par Masterbox - PCS por Masterbox - PCS por Masterbox	1 PCS
PCS per Euro Pallet - PCS par Euro Pallet - PCS por Euro Pallet - PCS por Euro Pallet	72 PCS
Code - Code - Código - Code	61735
Bar Code - Code barre - Código barra - Code à barres	8004386617359

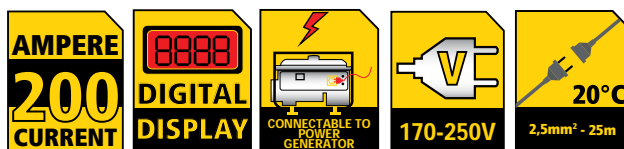

MMA INVERTER WELDING MACHINE WD130IV1



TECHNICAL SPECIFICATIONS	
Main Voltage - Tension de réseau - Voltaje de red - Tensão de rede	127V, 50-60Hz
Absorbed Power - Puissance absorbée - Potencia absorbida - Potência absorvida	3,8 kVA
No load Voltage - Tension à vide - Tensión en vacío - Tensão de vácuo	70V
Welding Current - Courant de soudage - Corriente de soldadura - Corrente de soldagem	10-100A (130MAX)
Duty Cycle - Cycle de service - Ciclo de trabajo - Ciclo de Trabalho - EN 60974-1	100A 20%
Duty Cycle - Cycle de service - Ciclo de trabajo - Ciclo de Trabalho - 20° C Normal Use	130A MAX@40%
Min-Max Electrode - Electrode Min-Max - Electrodo min-max - Electrodo min-max	1,6-3,2mm
Box volume - Volume carton - Volumen caja - Volume em dinheiro	0,01m ³
Box Size - Dimensions du carton - Cartón dimensiones - Dimensões de papelão	350x135x250mm
Box Weight - Poids de la boîte - Peso de la caja - Peso da caixa	3,8Kg
PCS per Masterbox - PCS par Masterbox - PCS por Masterbox - PCS por Masterbox	1 PCS
PCS per Euro Pallet - PCS par Euro Pallet - PCS por Euro Pallet - PCS por Euro Pallet	112 PCS
Code - Code - Código - Code	61090
Bar Code - Code barre - Código barra - Code à barres	8004386610909

Made in P.R.C



MMA INVERTER WELDING MACHINE

GB • Inverter technology welding machine, light, compact and reliable. Suitable for rutile electrodes.

F • Équipement de soudage avec technologie inverter. Léger, compact et fiable. Convient aux électrodes de rutile.

E • Equipo de soldadura con tecnología inverter. Ligero, compacto y confiable. Adecuado para electrodos de rutilio.

PT • Equipamento de soldagem com tecnologia inversora. Leve, compacto e confiável. Adequado para eletrodos rutilio.

- FR
- 1 Bracet haute résistance
- 2 Bouton de réglage
- 3 Indicateur de surchauffe
- 4 Connecteurs Dinse pour des connexions de câbles de soudage de haute qualité
- 5 Corps en métal pour une durabilité accrue

- E
- 1 Correa de alta resistencia
- 2 Perilla de regulación
- 3 Indicador de sobrecalentamiento
- 4 Conectores Dinse para conexiones de cables de soldadura de alta calidad
- 5 Cuerpo de metal para mayor durabilidad

- PT
- 1 Alça de alta resistência
- 2 Botão de regulação
- 3 Indicador de superaquecimento
- 4 Conectores Dinse para conexões de cabos de solda de alta qualidade
- 5 Corpo metálico para maior durabilidade



MULTIVOLT 160



TECHNICAL SPECIFICATIONS MMA		
Main Voltage - Tension de réseau - Voltaje de red - Tensão de rede	230V, 50-60Hz	127V, 50-60Hz
Absorbed Power - Puissance absorbée - Potencia absorbida - Potência absorvida	6,9kVA	5,0 kVA
No load Voltage - Tension à vide - Tensión en vacío - Tensão de vácuo	89V	89V
Welding Current - Courant de soudage - Corriente de soldadura - Corrente de soldagem	15-160	15-130A
Duty Cycle - Cycle de service - Ciclo de trabajo - Ciclo de Trabalho - EN 60974-1	160A 20%	130A 35%
Duty Cycle - Cycle de service - Ciclo de trabajo - Ciclo de Trabalho - 20° C Normal Use	160A@60%	130A@100%
Min-Max Electrode - Electrode Min-Max - Electrodo min-max - Electrodo min-max	1,6-4,0mm	1,6-3,2mm

TECHNICAL SPECIFICATIONS TIG		
Main Voltage - Tension de réseau - Voltaje de red - Tensão de rede	230V, 50-60Hz	127V, 50-60Hz
Absorbed Power - Puissance absorbée - Potencia absorbida - Potência absorvida	4,8 kVA	3,5 kVA
No load Voltage - Tension à vide - Tensión en vacío - Tensão de vácuo - U ₀ /U _r	89/14V	89/14V
Welding Current - Courant de soudage - Corriente de soldadura - Corrente de soldagem	15-160	15-130A
Duty Cycle - Cycle de service - Ciclo de trabajo - Ciclo de Trabalho - EN 60974-1	160A 40%	130A 50%
Duty Cycle - Cycle de service - Ciclo de trabalho - Ciclo de Trabalho - 20° C Normal Use	160A@100%	130A@100%
Min-Max Electrode - Electrode Min-Max - Electrodo min-max - Electrodo min-max	1,6-3,2mm	1,6-3,2mm

Box volume - Volume carton - Volumen caja - Volume em dinheiro	0,02m ³
Box Size - Dimensions du carton - Cartón dimensiones - Dimensões de papelão	370x160x300mm
Box Weight - Poids de la boîte - Peso de la caja - Peso da caixa	6,4Kg
PCS per Masterbox - PCS par Masterbox - PCS por Masterbox - PCS por Masterbox	1 PCS
PCS per Euro Pallet - PCS par Euro Pallet - PCS por Euro Pallet - PCS por Euro Pallet	72 PCS
Code - Code - Código - Code	67866
Bar Code - Code barre - Código barra - Code à barres	8004386678664

Made in P.R.C

MULTIVOLT 200



TECHNICAL SPECIFICATIONS MMA		
Main Voltage - Tension de réseau - Voltaje de red - Tensão de rede	230V, 50-60Hz	127V, 50-60Hz
Absorbed Power - Puissance absorbée - Potencia absorbida - Potência absorvida	9,2 kVA	5,9 kVA
No load Voltage - Tension à vide - Tensión en vacío - Tensão de vácuo	89V	89V
Welding Current - Courant de soudage - Corriente de soldadura - Corrente de soldagem	15-200	15-130A
Duty Cycle - Cycle de service - Ciclo de trabajo - Ciclo de Trabalho - EN 60974-1	200A 15%	130A 35%
Duty Cycle - Cycle de service - Ciclo de trabajo - Ciclo de Trabalho - 20° C Normal Use	200A@45%	200A@100%
Min-Max Electrode - Electrode Min-Max - Electrodo min-max - Electrodo min-max	1,6-5,0mm	1,6-3,2mm

TECHNICAL SPECIFICATIONS TIG		
Main Voltage - Tension de réseau - Voltaje de red - Tensão de rede	230V, 50-60Hz	127V, 50-60Hz
Absorbed Power - Puissance absorbée - Potencia absorbida - Potência absorvida	6,4 kVA	3,7 kVA
No load Voltage - Tension à vide - Tensión en vacío - Tensão de vácuo - U ₀ /U _r	89/14V	89/14V
Welding Current - Courant de soudage - Corriente de soldadura - Corrente de soldagem	15-200	15-130A
Duty Cycle - Cycle de service - Ciclo de trabalho - Ciclo de Trabalho - EN 60974-1	200A 30%	130A 50%
Duty Cycle - Cycle de service - Ciclo de trabalho - Ciclo de Trabalho - 20° C Normal Use	200A@90%	130A@100%
Min-Max Electrode - Electrode Min-Max - Electrodo min-max - Electrodo min-max	1,6-3,2mm	1,6-3,2mm

Box volume - Volume carton - Volumen caja - Volume em dinheiro	0,02m ³
Box Size - Dimensions du carton - Cartón dimensiones - Dimensões de papelão	370x160x300mm
Box Weight - Poids de la boîte - Peso de la caja - Peso da caixa	6,5Kg
PCS per Masterbox - PCS par Masterbox - PCS por Masterbox - PCS por Masterbox	1 PCS
PCS per Euro Pallet - PCS par Euro Pallet - PCS por Euro Pallet - PCS por Euro Pallet	72 PCS
Code - Code - Código - Code	67876
Bar Code - Code barre - Código barra - Code à barres	8004386678763

Made in P.R.C

STANLEY CASE

GB • Metal Plastic Toolbox with tray. Very large metal body. Integrated V-grooves on top lid. Large metal rust proof latches with padlock eye. Bi-material ergonomic handle.

FR • Boîte métalloplastique avec réservoir. Corps en métal. Rainures très spacieux. Couvercle à rainure en <V>. Grandes charnières antirouille avec cadenas de serrure. Poignée ergonomique bi-matière.

E • Caja de herramientas plástica-metálica con bandeja. Cuerpo de metal muy espacioso. Runuras en V integradas en la tapa superior. Pestillos metálicos resistentes a la oxidación con seguro. Mango ergonómico bi-material.

PT • Caixa de ferramentas de plástico-metal com bandeja. Corpo de metal muito espaçoso. Ranhuras em V integradas na tampa superior. Travas metálicas resistentes à oxidação com seguro. Alça ergonômica bi-material.



• FR
 1 Structure robuste avec charnières métalliques
 2 Poignée bi-matière ergonomique
 3 Les grands verrous antirouille en métal gardent les outils en sécurité
 4 V rainure sur le couvercle supérieur
 5 Transport facile de charges lourdes supplémentaires
 6 La grande boîte fournit la taille supplémentaire pour l'espace de stockage

• E
 1 Estructura robusta con bisagras de metal
 2 mango bi-material ergonómico
 3 cerraduras antióxido de metal grandes mantienen las herramientas seguras
 4 Ranura en V en la cubierta superior
 5 Transporte fácil de cargas extra pesadas
 6 La caja grande proporciona un tamaño adicional para el espacio de almacenamiento

• PT
 1 Estrutura robusta com dobradiças de metal
 2 Alça bi-material ergonômica
 3 Grandes fechaduras anti-ferrugem de metal mantêm as ferramentas seguras
 4 V sulco na tampa superior
 5 Fácil transporte de cargas extra pesadas
 6 Caixa grande fornece tamanho extra para o espaço de armazenamento



MMA INVERTER WELDING MACHINE

GB • Inverter technology welding machine, light, compact and reliable. Suitable for rutile electrodes.

E • Equipo de soldadura con tecnología inverter. Ligero, compacto y confiable. Adecuado para electrodos de rutilio.

F • Équipement de soudage avec technologie inverter. Léger, compact et fiable. Convient aux électrodes de rutile.

PT • Equipamento de soldagem com tecnologia inversora. Leve, compacto e confiável. Adequado para eletrodos rutilo.



- FR
- 1 Bracelet haute résistance
- 2 Bouton de réglage
- 3 Indicateur de surchauffe
- 4 Connecteurs Dinse pour des connexions de câbles de soudage de haute qualité
- 5 Corps en métal pour une durabilité accrue
- E
- 1 Correa de alta resistencia
- 2 Perilla de regulación
- 3 Indicador de sobrecalentamiento
- 4 Conectores Dinse para conexiones de cables de soldadura de alta calidad
- 5 Cuerpo de metal para mayor durabilidad
- PT
- 1 Alça de alta resistência
- 2 Botão de regulação
- 3 Indicador de superaquecimento
- 4 Conectores Dinse para conexões de cabos de solda de alta qualidade
- 5 Corpo metálico para maior durabilidade



POWER 185 TIG LIFT



TECHNICAL SPECIFICATIONS MMA	
Main Voltage - Tension de réseau - Voltaje de red - Tensão de rede	230V, 50-60Hz
Absorbed Power - Puissance absorbée - Potencia absorbida - Potência absorvida	3,2 kVA - 80%
No load Voltage - Tension à vide - Tension en vacío - Tensão de vácuo	90V
Welding Current - Courant de soudage - Corriente de soldadura - Corrente de soldagem	30-160A
Duty Cycle - Cycle de service - Ciclo de trabajo - Ciclo de Trabalho* - EN 60974-1	160A 15%
Duty Cycle - Cycle de service - Ciclo de trabajo - Ciclo de Trabalho* - 20° Normal use	160A@30%
Min-Max Electrode - Electrode Min-Max - Electrodo min-max - Electrodo min-max	1,6-4,0mm

TECHNICAL SPECIFICATIONS TIG	
Main Voltage - Tension de réseau - Voltaje de red - Tensão de rede	230V, 50-60Hz
Absorbed Power - Puissance absorbée - Potencia absorbida - Potência absorvida	3,2 kVA - 80%
No load Voltage - Tension à vide - Tension en vacío - Tensão de vácuo	90V
Welding Current - Courant de soudage - Corriente de soldadura - Corrente de soldagem	30-160A
Duty Cycle - Cycle de service - Ciclo de trabajo - Ciclo de Trabalho* - EN 60974-1	160A 15%
Duty Cycle - Cycle de service - Ciclo de trabajo - Ciclo de Trabalho* - 20° Normal use	160A@30%
Min-Max Electrode - Electrode Min-Max - Electrodo min-max - Electrodo min-max	1,6-4,0mm

Box volume - Volume carton - Volumen caja - Volume em dinheiro	0,045m ³
Box Size - Dimensions du carton - Cartón dimensiones - Dimensões de papelão	600x300x250mm
Box Weight - Poids de la boîte - Peso de la caja - Peso da caixa	10,2Kg
PCS per Masterbox - PCS par Masterbox - PCS por Masterbox - PCS por Masterbox	1 PCS
PCS per Euro Pallet - PCS par Euro Pallet - PCS por Euro Pallet - PCS por Euro Pallet	36 PCS
Code - Code - Código - Code	60199
Bar Code - Code barre - Código barra - Code à barres	8004386601990

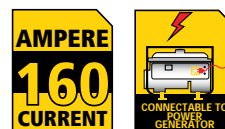
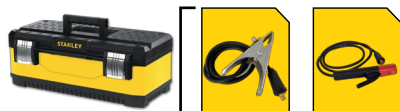

MMA - TIG LIFT INVERTER WELDING MACHINE

GB • Inverter technology welding machine, light, compact and reliable. Suitable for rutile electrodes.

E • Equipo de soldadura con tecnología inverter. Ligero, compacto y confiable. Adecuado para electrodos de rutilo.

F • Équipement de soudage avec technologie inverter. Léger, compact et fiable. Convient aux électrodes de rutil.

PT • Equipamento de soldagem com tecnologia inversora. Leve, compacto e confiável. Adequado para eletrodos rutilo.

• FR

- 1 Bracelet haute résistance
 - 2 Bouton de réglage
 - 3 Indicateur de surchauffe
 - 4 Connecteurs Dinse pour des connexions de câbles de soudage de haute qualité
 - 5 Corps en métal pour une durabilité accrue
- E
- 1 Correa de alta resistencia
 - 2 Perilla de regulación
 - 3 Indicador de sobrecalentamiento
 - 4 Conectores Dinse para conexiones de cables de soldadura de alta calidad
 - 5 Cuerpo de metal para mayor durabilidad
- PT
- 1 Alça de alta resistência
 - 2 Botão de regulação
 - 3 Indicador de superaquecimento
 - 4 Conectores Dinse para conexões de cabos de solda de alta qualidade
 - 5 Corpo metálico para maior durabilidade



SUPER 180 TIG LIFT



64179



64180

TECHNICAL SPECIFICATIONS MMA

Main Voltage - Tension de réseau - Voltaje de red - Tensão de rede	230V, 50-60Hz
Absorbed Power - Puissance absorbée - Potencia absorbida - Potência absorvida	6,6kVA
No load Voltage - Tension à vide - Tensión en vacío - Tensão de vácuo	90V
Welding Current - Courant de soudage - Corriente de soldadura - Corrente de soldagem	15-160A
Duty Cycle - Cycle de service - Ciclo de trabajo - Ciclo de Trabalho - EN 60974-1	160A 20%
Duty Cycle - Cycle de service - Ciclo de trabalho - Ciclo de Trabalho* - 20° Normal use	160A@60%
Min-Max Electrode - Electrode Min-Max - Electrodo min-max - Electrodo min-max	1,6-4,0mm

TECHNICAL SPECIFICATIONS TIG

Main Voltage - Tension de réseau - Voltaje de red - Tensão de rede	230V, 50-60Hz
Absorbed Power - Puissance absorbée - Potencia absorbida - Potência absorvida	4,5kVA
No load Voltage - Tension à vide - Tensión en vacío - Tensão de vácuo	14V
Welding Current - Courant de soudage - Corriente de soldadura - Corrente de soldagem	15-160A
Duty Cycle - Cycle de service - Ciclo de trabajo - Ciclo de Trabalho - EN 60974-1	160A 20%
Duty Cycle - Cycle de service - Ciclo de trabalho - Ciclo de Trabalho* - 20° Normal use	160A@60%
Min-Max Electrode - Electrode Min-Max - Electrodo min-max - Electrodo min-max	0,5-2,4mm Tungsten

Box volume - Volume carton - Volumen caja - Volume em dinheiro	0,045m³
Box Size - Dimensions du carton - Cartón dimensiones - Dimensões de papelão	600x300x250mm
Box Weight - Poids de la boîte - Peso de la caja - Peso da caixa	9,9Kg
PCS per Masterbox - PCS par Masterbox - PCS por Masterbox - PCS por Masterbox	1 PCS
PCS per Euro Pallet - PCS par Euro Pallet - PCS por Euro Pallet - PCS por Euro Pallet	36 PCS
Code - Code - Código - Code	64179
Bar Code - Code barre - Código barra - Code à barres	8004386641798

Box volume - Volume carton - Volumen caja - Volume em dinheiro	0,045m³
Box Size - Dimensions du carton - Cartón dimensiones - Dimensões de papelão	600x300x250mm
Box Weight - Poids de la boîte - Peso de la caja - Peso da caixa	8,3Kg
PCS per Masterbox - PCS par Masterbox - PCS por Masterbox - PCS por Masterbox	1 PCS
PCS per Euro Pallet - PCS par Euro Pallet - PCS por Euro Pallet - PCS por Euro Pallet	36 PCS
Code - Code - Código - Code	64180
Bar Code - Code barre - Código barra - Code à barres	8004386641804

ELECTRODES

Rutile - AWS E6013
Stainless Steels - AWS E308
Basic - AWS E7018
Cast Iron - AWS A5.15





PROFES CUSTO

**LE PROFESSIONNALISME
DONT LES CLIENTS
ONT BESOIN**

**LA PR
QUI**

PROFESIONAL MERCHANTS NEEDS

PROFESIONALIDAD
DE LOS CLIENTES
NECESITAN.

O PROFESIONALISMO
QUE OS CLIENTES
PRECISAM



**MIG
MAG
MOG
WELDING**

Welding "MIG" is distinguished in: "MIG GAS" where the material used is a metal in the form of a wire and the deoxidization and a gas, generally CO₂, Argon or CO₂+Argon.

"MIG NO-GAS" where the thread contains within the dioxidiser.

Le soudage "MIG" se distingue par : "GAZ MIG" : le matériau utilisé est un métal sous forme de fil et l'oxydation est limitée par un gaz, généralement du CO₂, de l'Argon ou CO₂+Argon. "MIG SANS GAS" : le fil est contenu dans le désoxydant.

La soldadura "MIG" se distingue por: "MIG GAS": el material utilizado es un metal con forma de alambre, y el desoxidante es un gas, normalmente CO₂, Argón o CO₂+Argón. "MIG NO-GAS": el alambre contiene al interno el desoxidante.

A soldadura "MIG" se distingue por: "MIG GÁS": o material utilizado é um metal de forma livre, e o gás desoxidante, normalmente CO₂, Argón o CO₂ + Argón. "MIG NO-GAS": el alambre contiene al interno el desoxidante.

MIG/MAG/MOG INVERTER WELDING MACHINE -TOP MIG 1400

GB • Inverter technology welding machine, for heavy duty. MIG/MAG/MOG.

F • Équipement de soudage avec technologie inverter, pour usage professionnel. MIG/MAG/MOG.

E • Equipo de soldadura con tecnología inverter, para trabajos pesados. MIG/MAG/MOG.

PT • Equipamento de soldagem com tecnologia inversora, para trabalhos pesados. MIG/MAG/MOG.

1 • Handle with ergonomic design

4 • Metal body for added durability

3 • Regulation knob

• FR

- 1 Poignée avec un design ergonomique
- 2 Affichage numérique
- 3 Bouton de réglage
- 4 Corps en métal pour durabilité accrue

• E

- 1 Poignée avec un design ergonomique
- 2 Affichage numérique
- 3 Bouton de réglage
- 4 Corps en métal pour durabilité acumulada

• PT

- 1 Poignée com design ergonômico
- 2 Affichage numérique
- 3 Bouton de réglage
- 4 Corpos de metal para maior durabilidade



TECHNICAL SPECIFICATIONS		TOP MIG 1400
Absorbed Power - Puissance absorbée - Potencia absorbida - Potência absorvida		4,9 kVA 3,6 kW
No load Voltage - Tension à vide - Tensión en vacío - Tensão de vácuo		51V
Welding Current - Courant de soudage - Corriente de soldadura - Corrente de soldagem		30-135A
Duty Cycle - Cycle de service - Ciclo de trabajo - Ciclo de Trabalho - X _W /I _Z [A] 40° IEC 60974-1		20/135A
Duty Cycle - Cycle de service - Ciclo de trabajo - Ciclo de Trabalho - 20° C		135A@60%
Main Voltage - Tension de réseau - Voltaje de red - Tensão de rede		230V, 50-60Hz
Absorbed Power - Puissance absorbée - Potencia absorbida - Potência absorvida		4,9 kVA 3,6 kW
No load Voltage - Tension à vide - Tensión en vacío - Tensão de vácuo		51V
Welding Current - Courant de soudage - Corriente de soldadura - Corrente de soldagem		20-120A
Duty Cycle - Cycle de service - Ciclo de trabajo - Ciclo de Trabalho - X _W /I _Z [A] 40° IEC 60974-1		20/120A
Min-Max Electrode - Electrode Min-Max - Electrodo min-max - Electrodo min-max		1,6-2,5(3,2)mm
Absorbed Power - Puissance absorbée - Potencia absorbida - Potência absorvida		3,3 kVA 2,4 kW
No load Voltage - Tension à vide - Tensión en vacío - Tensão de vácuo		51V
Welding Current - Courant de soudage - Corriente de soldadura - Corrente de soldagem		20-120A
Duty Cycle - Cycle de service - Ciclo de trabajo - Ciclo de Trabalho - X _W /I _Z [A] 40° IEC 60974-1		20/120A
Box volume - Volume carton - Volumen caja - Volume em dinheiro		0,038m ³
Box Size - Dimensions du carton - Cartón dimensiones - Dimensões de papelão		480x230x345mm
Box Weight - Poids de la boîte - Peso de la caja - Peso da caixa		11,5Kg
PCS per Masterbox - PCS par Masterbox - PCS por Masterbox - PCS por Masterbox		1 PCS
PCS per Euro Pallet - PCS par Euro Pallet - PCS por Euro Pallet - PCS por Euro Pallet		35 PCS
Code - Code - Código - Code		58940
Bar Code - Code barre - Código barra - Code à barres		8004386589403





MMA



TIG



MIG

**BEST
IN
CLASS**

Provides maximum portability and performance in the most compact MMA - MIG/MAG/ MOG - TIG LIFT welding machine in the industry.

Fournit une portabilité et une performance maximales dans la machine de soudage MMA - MIG / MAG / MOG - TIG LIFT la plus compacte de l'industrie.

Proporciona el máximo de la portabilidad y del rendimiento en la mas compacta máquina de soldar MMA - MIG/MAG/MOG - TIG LIFT de la industria.

Proporciona a máxima portabilidade e desempenho na mais compacta máquina de solda MMA - MIG/MAG/MOG - TIG LIFT do setor.

MIG/MAG/MOG - TIG LIFT - MMA INVERTER WELDING MACHINE

GB • Inverter technology welding machine, for heavy duty. MIG/MAG/MOG - TIG LIFT - MMA. Voltage, current and inductance automatic regulation on MIG MAG mode.

F • Équipement de soudage avec technologie inverter, pour usage professionnel. MIG/MAG/MOG - TIG LIFT - MMA. Régulation automatique de la tension, du courant et de l'inductance en mode MIG MAG.

E • Equipo de soldadura con tecnología inverter, para trabajos pesados. MIG/MAG/MOG - TIG LIFT - MMA. Regulación automática de la tensión, corriente e inductancia en función MIG MAG.

PT • Equipamento de soldagem com tecnologia inversora, para trabalhos pesados. MIG/MAG/MOG - TIG LIFT - MMA. Regulação automática da tensão, corrente e indutância na função MIG MAG.



- FR
- 1 Poignée solide
- 2 Affichage numérique
- 3 Bouton de réglage
- 4 Connecteur Euro
- 5 Connecteurs Dinse pour des connexions de câbles de soudage de haute qualité
- 6 Connecteur SPOOL GUN
- 7 Corps en métal pour durabilité accrue
- E
- 1 Mango fuerte
- 2 Pantalla digital
- 3 Perilla de regulación
- 4 Conector euro
- 5 Conectores Dinse para conexiones de cables de soldadura de alta calidad
- 6 Conector SPOOL GUN
- 7 Cuerpo de metal para durabilidad añadida
- PT
- 1 Alça forte
- 2 Display digital
- 3 Botão de regulação
- 4 Conector Euro
- 5 Conectores Dinse para conexões de cabos de solda de alta qualidade
- 6 Conector SPOOL GUN
- 7 Corpo metálico para maior durabilidade



TOP MIG 1800



TECHNICAL SPECIFICATIONS		MMA
Main Voltage - Tension de réseau - Voltaje de red - Tensão de rede		230V, 50-60Hz
Absorbed Power - Puissance absorbée - Potencia absorbida - Potência absorvida		8,3 kVA - MAX
No load Voltage - Tension à vide - Tensión en vacío - Tensão de vácuo		65V
Welding Current - Courant de soudage - Corriente de soldadura - Corrente de soldagem		16-200A
Duty Cycle - Cycle de service - Ciclo de trabajo - Ciclo de Trabalho - 20° C Normal Use		200A@60%
Min-Max Electrode - Electrode Min-Max - Electrodo min-max - Electrodo min-max		1,6-5,0mm
		TIG
Main Voltage - Tension de réseau - Voltaje de red - Tensão de rede		230V, 50-60Hz
Absorbed Power - Puissance absorbée - Potencia absorbida - Potência absorvida		6,2 kVA - MAX
No load Voltage - Tension à vide - Tensión en vacío - Tensão de vácuo		65V
Welding Current - Courant de soudage - Corriente de soldadura - Corrente de soldagem		15-200A
Duty Cycle - Cycle de service - Ciclo de trabajo - Ciclo de Trabalho - 20° C Normal Use		200A@60%
Min-Max Electrode - Electrode Min-Max - Electrodo min-max - Electrodo min-max		1,6-3,2mm
		MIG
Main Voltage - Tension de réseau - Voltaje de red - Tensão de rede		230V, 50-60Hz
Absorbed Power - Puissance absorbée - Potencia absorbida - Potência absorvida		8,2 kVA - MAX
No load Voltage - Tension à vide - Tensión en vacío - Tensão de vácuo		65V
Welding Current - Courant de soudage - Corriente de soldadura - Corrente de soldagem		40-200A
Duty Cycle - Cycle de service - Ciclo de trabajo - Ciclo de Trabalho - 20° C Normal Use		200A@60%
Min-Max Wire - Fil Min-Max - Cable min-max - Fio min-max		*
Box volume - Volume carton - Volumen caja - Volume em dinheiro		0,065m ³
Box Size - Dimensions du carton - Carton dimensiones - Dimensões de papelão		625x245x440mm
Box Weight - Poids de la boîte - Peso da caixa - Peso da caixa		18,1Kg
PCS per Masterbox - PCS par Masterbox - PCS por Masterbox - PCS por Masterbox		1 PCS
PCS per Euro Pallet - PCS par Euro Pallet - PCS por Euro Pallet - PCS por Euro Pallet		20 PCS
Code - Code - Código - Code		59040
Bar Code - Code barre - Código barra - Code à barres		8004386590409

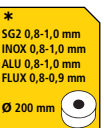

MIG/MAG/MOG WELDING MACHINE

GB • MOG welding machine (no gas) compact, flux cored wire accessoried.
FR • Poste à souder MOG (no gaz) compact, fourni avec fil fourré.

E • Equipo de soldadura MOG (no gas) compacto, equipado con hilo animado.
PT • Equipamento de solda MIG (não gasoso) compacto, equipado com fio animado.
I • Saldatrice MOG (no gas) compatta, accessoriata con filo animato.

D • MOG Schweissmaschine (no gas), klein und kompakt, ausgerüstet mit Fi illdraht.
RU • Компактный сварочный аппарат для безгазовой сварки.



1 • Durable plastic handle

4 • Regulation knob

added durability

• FR

- 1 Manche en plastique durable
- 2 Corps en métal pour une durabilité accrue
- 3 Indicateur de surchauffe
- 4 Bouton de réglage

• E

- 1 Cable de plástico duradero
- 2 Cuerpo metálico para mayor durabilidad
- 3 Indicador de sobrecalentamiento
- 4 Botón de regulación

• PT

- 1 Cabo de plástico durável
- 2 Corpo metálico para maior durabilidade
- 3 Indicador de superaquecimento
- 4 Botão de regulação

• I

- 1 Maniglia in plastica resistente
- 2 Corpo in metallo robusto e durevole
- 3 Indicatore di surriscaldamento
- 4 Manopola di regolazione

• D

- 1 Resistentes Kunststoffgriff
- 2 Metallkörper für längere Haltbarkeit
- 3 Überhitzungsanzeige
- 4 Einstellknopf

• RU

- 1 Ручка из устойчивой пластмассы долговечности
- 2 Прочный и прочный металлический корпус
- 3 Индикатор перегрева
- 4 Регулировочная ручка

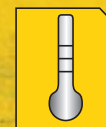

MIKROMIG



TECHNICAL SPECIFICATIONS	
Main Voltage - Tension de réseau - Voltaje de red - Tensão de rede	230V, 50-60Hz
Absorbed Power - Puissance absorbée - Potencia absorbida - Potência absorvida	2,8 kVA - 2,6kW
No load Voltage - Tension à vide - Tensión en vacío - Tensão de vácuo	18/25V
	35-95A
Duty Cycle - Cycle de service - Ciclo de trabajo - Ciclo de Trabalho	6A 95%

Box volume - Volume carton - Volumen caja - Volume em dinheiro	0,03m ³
Box Size - Dimensions du carton - Cartón dimensiones - Dimensões de papelão	370x331x225mm
Box Weight - Poids de la boîte - Peso de la caja - Peso da caixa	13,6Kg
PCS per Masterbox - PCS par Masterbox - PCS por Masterbox - PCS por Masterbox	1 PCS
PCS per Euro Pallet - PCS par Euro Pallet - PCS por Euro Pallet - PCS por Euro Pallet	50 PCS
Code - Code - Código - Code	10880
Bar Code - Code barre - Código barra - Code à barres	8004386108802

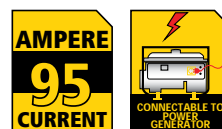
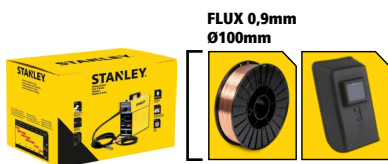

STARMIG 130



TECHNICAL SPECIFICATIONS	
Main Voltage - Tension de réseau - Voltaje de red - Tensão de rede	230V, 50-60Hz
Absorbed Power - Puissance absorbée - Potencia absorbida - Potência absorvida	2,8 kVA - 2,6kW
No load Voltage - Tension à vide - Tensión en vacío - Tensão de vácuo	18/25V
	35-95A 130MAX
Duty Cycle - Cycle de service - Ciclo de trabajo - Ciclo de Trabalho	6A 95%

Box volume - Volume carton - Volumen caja - Volume em dinheiro	0,03m ³
Box Size - Dimensions du carton - Cartón dimensiones - Dimensões de papelão	370x331x225mm
Box Weight - Poids de la boîte - Peso de la caja - Peso da caixa	13,9Kg
PCS per Masterbox - PCS par Masterbox - PCS por Masterbox - PCS por Masterbox	1 PCS
PCS per Euro Pallet - PCS par Euro Pallet - PCS por Euro Pallet - PCS por Euro Pallet	50 PCS
Code - Code - Código - Code	10740
Bar Code - Code barre - Código barra - Code à barres	8004386107409

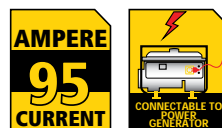



TIG

In TIG welding the heat is produced by the electric arc between a nonconsumable electrode (tungsten) and the piece to be welded, by the flow of an inert gas. The tungsten electrode is supported by a torch suitable for transmitting the welding current and protecting the electrode itself and the weld pool from atmospheric oxidation, by the flow of an inert gas which flows out of the ceramic nozzle.

Pour le soudage TIG, la chaleur est produite par l'arc électrique entre une électrode non-consommable (en tungstène) et la pièce à souder au moyen d'un gaz inerte. L'électrode en tungstène est supportée par une torche qui convient à la transmission du courant de soudage et à la protection de l'électrode elle-même, et de la soudure de l'oxydation atmosphérique au moyen d'un débit de gaz inerte qui est projeté par la buse en céramique.

En la soldadura TIG el calor necesario para la soldadura es suministrado por un arco eléctrico entre un electrodo inconsumible (tungsteno) y la pieza a soldar, bajo la protección de un flujo de un gas inerte que sale de la boquilla de cerámica. El electrodo de tungsteno es soportado por una antorcha que transmite la corriente de soldadura y a su vez protege al electrodo mismo y al baño de soldadura de la oxidación atmosférica.

Na soldagem TIG, o calor necessário para a soldagem é fornecido por um arco elétrico entre um eletrodo não consumível (tungstênio) e a peça de trabalho, sob a proteção de um fluxo de gás inerte que sai do bocal de cerâmica. O eletrodo de tungstênio é suportado por uma tocha que transmite a corrente de soldagem e, por sua vez, protege o próprio eletrodo e a poça de fusão da oxidação atmosférica.

TIG HF DC PULSE - INVERTER WELDING MACHINE

GB • TIG DC welding machine with inverter technology. Equipped with high frequency.

F • Poste à souder avec technologie inverter, pour le soudure TIG DC. Equipé de haut fréquence pour l'allumage de la torche.

E • Equipo de soldadura con tecnología inverter, para soldadura TIG DC. Equipado con alta frecuencia para el encendido de la antorcha.

PT • E • Equipamento de soldagem com tecnologia inversora, para soldagem DC TIG. Equipado com alta frequência para a ignição da tocha.



- FR
- 1 Poignée solide
- 2 Affichage numérique
- 3 Bouton de réglage
- 4 Connecteur Gas
- 5 Connecteurs Dinse pour des connexions de câbles de soudage de haute qualité
- 6 Connecteur des câbles de pousoir torche
- 7 Corps en métal pour durabilité accrue
- E
- 1 Mango fuerte
- 2 Pantalla digital
- 3 Perilla de regulación
- 4 Conector Gas
- 5 Conectores Dinse para conexiones de cables de soldadura de alta calidad
- 6 Conector del cable empujador de la antorcha
- 7 Cuerpo de metal para durabilidad añadida
- PT
- 1 Alça forte
- 2 Display digital
- 3 Botão de regulação
- 4 Conector Gaz
- 5 Conectores Dinse para conexões de cabos de solda de alta qualidade
- 6 Conector do cabo da tocha
- 7 Corpo metálico para maior durabilidade



TIG 201 I HF-DC PULSE



TECHNICAL SPECIFICATIONS	MMA
Main Voltage - Tension de réseau - Voltaje de red - Tensão de rede	230V, 50-60Hz
Absorbed Power - Puissance absorbée - Potencia absorbida - Potência absorvida	6,5 kVA - MAX 3,5 kVA - 60%
No load Voltage - Tension à vide - Tensión en vacío - Tensão de vácuo	65V
Welding Current - Courant de soudage - Corriente de soldadura - Corrente de soldagem	20-160A
Duty Cycle - Cycle de service - Ciclo de trabajo - Ciclo de Trabalho - 20° C Normal Use	160A@60%
Min-Max Electrode - Electrode Min-Max - Electrodo min-max - Electrodo min-max	1,6-4,0mm

	TIG
Main Voltage - Tension de réseau - Voltaje de red - Tensão de rede	230V, 50-60Hz
Absorbed Power - Puissance absorbée - Potencia absorbida - Potência absorvida	6,0 kVA - MAX 3 kVA - 60%
No load Voltage - Tension à vide - Tensión en vacío - Tensão de vácuo	65V
Welding Current - Courant de soudage - Corriente de soldadura - Corrente de soldagem	5-200A
Duty Cycle - Cycle de service - Ciclo de trabajo - Ciclo de Trabalho - 20° C Normal Use	200A@60%
Min-Max Electrode - Electrode Min-Max - Electrodo min-max - Electrodo min-max	1,6-3,2mm (Tungsten)

Box volume - Volume carton - Volumen caja - Volume em dinheiro	0,035m ³
Box Size - Dimensions du carton - Cartón dimensiones - Dimensões de papelão	450x230x360mm
Box Weight - Poids de la boîte - Peso de la caja - Peso da caixa	11,1Kg
PCS per Masterbox - PCS par Masterbox - PCS por Masterbox - PCS por Masterbox	1 PCS
PCS per Euro Pallet - PCS par Euro Pallet - PCS por Euro Pallet - PCS por Euro Pallet	35 PCS
Code - Code - Código - Code	58169
Bar Code - Code barre - Código barra - Code à barres	8004386581698



PROTECTION AND JOB SAFETY

PROTECTION ET
SÉCURITÉ D'EMPLOI

PROTECCIÓN Y SEGURIDAD
EN EL TRABAJO

PROTEÇÃO E SEGURANÇA
DO TRABALHO

E-PROTECTION 2000E-11



TECHNICAL SPECIFICATIONS	
Delay Time - Temporisation - Tiempo de retardo - Tempo de atraso	0,1 - 0,8s
Switching time - Temps de commutation - Tiempo de cambio - Tempo de cambio	<1/10000ms
DIN	11 FIX
Viewing area - Zone de visualisation - Área de visualización - Área de visualização	96x39mm
Optical class - Classe optique - Clase óptica - Classe ótica	1/1/1/2
Light sensors - Capteurs de lumière - Sensores de luz - Sensores de luz	2
Box volume - Volume carton - Volumen caja - Volume em dinheiro	0,016m ³
Box Size - Dimensions du carton - Cartón dimensiones - Dimensões de papelão	330x230x220mm
Box Weight - Poids de la boîte - Peso de la caja - Peso da caixa	0,9Kq
PCS per Masterbox - PCS par Masterbox - PCS por Masterbox - PCS por Masterbox	1 PCS
PCS per Euro Pallet - PCS par Euro Pallet - PCS por Euro Pallet - PCS por Euro Pallet	80 PCS
Code - Code - Código - Code	90371
Bar Code - Code barre - Código barra - Code à barres	8004386903711



E-PROTECTION 2000E



TECHNICAL SPECIFICATIONS	
Delay Time - Temporisation - Tiempo de retardo - Tempo de atraso	0,1 - 1s
Switching time - Temps de commutation - Tiempo de cambio - Tempo de cambio	<1/30000ms
DIN	9-13
Viewing area - Zone de visualisation - Área de visualización - Área de visualização	96x39mm
Optical class - Classe optique - Clase óptica - Classe ótica	1/1/1/2
Light sensors - Capteurs de lumière - Sensores de luz - Sensores de luz	2
Box volume - Volume carton - Volumen caja - Volume em dinheiro	0,016m ³
Box Size - Dimensions du carton - Cartón dimensiones - Dimensões de papelão	330x230x220mm
Box Weight - Poids de la boîte - Peso de la caja - Peso da caixa	0,9Kq
PCS per Masterbox - PCS par Masterbox - PCS por Masterbox - PCS por Masterbox	1 PCS
PCS per Euro Pallet - PCS par Euro Pallet - PCS por Euro Pallet - PCS por Euro Pallet	80 PCS
Code - Code - Código - Code	90369
Bar Code - Code barre - Código barra - Code à barres	8004386903698



PROTECTOR 1000



TECHNICAL SPECIFICATIONS	PROTECTOR 1000
DIN	DIN 11 FIX
Viewing area - Zone de visualisation - Área de visualización - Área de visualização	75x98mm
Box Weight - Poids de la boîte - Peso de la caja - Peso da caixa	350 g
PCS per Masterbox - PCS par Masterbox - PCS por Masterbox - PCS por Masterbox	6 PCS
PCS per Euro Pallet - PCS par Euro Pallet - PCS por Euro Pallet - PCS por Euro Pallet	200 PCS
Code - Code - Código - Code	90363
Bar Code - Code barre - Código barra - Code à barres	8004386903636

E-PROTECTION 2000-C FLIP UP



TECHNICAL SPECIFICATIONS	E-PROTECTION 2000-C FLIP UP
DIN	DIN 11 FIX
Viewing area - Zone de visualisation - Área de visualización - Área de visualização	41x95mm
Box Weight - Poids de la boîte - Peso de la caja - Peso da caixa	800 g
PCS per Masterbox - PCS par Masterbox - PCS por Masterbox - PCS por Masterbox	1 PCS
PCS per Euro Pallet - PCS par Euro Pallet - PCS por Euro Pallet - PCS por Euro Pallet	80 PCS
Code - Code - Código - Code	90319
Bar Code - Code barre - Código barra - Code à barres	8004386903193

ACCESSORIES

ELITE 300

Electrode Holder
Pince porte-électrode
Pinza porta electrodo
Pinza porta electrodo

⊗ Cable: 25-50mm²
X% 35%: 400A
60%: 300A



88301

Pcs for blister: 1
Pcs for master: 35
Pcs for europallet: 700

ELITE 500

Electrode Holder
Pince porte-électrode
Pinza porta electrodo
Pinza porta electrodo

⊗ Cable: 35-70mm²
X% 35%: 500A
60%: 400A



88501

Pcs for blister: 1
Pcs for master: 35
Pcs for europallet: 700

EARTH 300

Earth clamp
Pince de terre
Pinza de masa
Pinza da terra

⊗ Cable: 10-35mm²
X% 35%: 300A
60%: 250A



89301

Pcs for blister: 1
Pcs for master: 35
Pcs for europallet: 700

EARTH 500

Earth clamp
Pince de terre
Pinza de masa
Pinza da terra

⊗ Cable: 25-70mm²
X% 35%: 500A
60%: 350A



89501

Pcs for blister: 1
Pcs for master: 35
Pcs for europallet: 700

WELDING KIT

Electrode Holder + Earth clamp - DINSE 10/25
Pince porte-électrode + Pinza de masa - DINSE 10/25
Pinza porta electrodo + Pinza de masa - DINSE 10/25
Pinza porta electrodo + Pinza da terra - DINSE 10/25

D:16mm² x 1,5 m



98012

Pcs for box: 2
Pcs for master: 5
Pcs for europallet: 210

Electrode Holder + Earth clamp - DINSE 35/50
Pince porte-électrode + Pinza de masa - DINSE 35/50
Pinza porta electrodo + Pinza de masa - DINSE 35/50
Pinza porta electrodo + Pinza da terra - DINSE 35/50

D:25mm² x 1,8 m



98013

Pcs for box: 2
Pcs for master: 5
Pcs for europallet: 210

CABLE

Welding cable
Area: 25mm² / L: 5 m





90084





Pcs for box: 1
Pcs for master: 5
Pcs for europallet: 210

ACCESSORIES

CONNECTORS

DINSE PLUG (Male) 10/25		98014 Pcs for blister: 2 Pcs for master: 50 Pcs for europallet: 1000
DINSE PLUG (Male) 35/50		98015 Pcs for blister: 2 Pcs for master: 50 Pcs for europallet: 1000
DINSE (Female) 10/25 + DINSE PLUG (Male) 10/25		98044 Pcs for blister: 2 Pcs for master: 50 Pcs for europallet: 1000
DINSE (Female) 35/50 + DINSE PLUG (Male) 35/50		98045 Pcs for blister: 2 Pcs for master: 50 Pcs for europallet: 1000

ACCESSORIES & OTHERS

Welding Apron 60X90 cm  Class 2 A1+A2		98011 Pcs for box: 1 Pcs for master: 5 Pcs for europallet: 210
Chipping hammer		90301 Pcs for blister: 1 Pcs for master: 35 Pcs for europallet: 700
Hammer brush		90082 Pcs for blister: 1 Pcs for master: 35 Pcs for europallet: 700
Hammer		90010 Pcs for blister: 1 Pcs for master: 35 Pcs for europallet: 700

ACCESSORIES

ACCESSORIES & OTHERS

Mini magnetic help set		<p>98026 Pcs for blister: 4 Pcs for master: 24 Pcs for europallet: 480</p>
Magnetic help		<p>98031 Pcs for blister: 1 Pcs for master: 50 Pcs for europallet: 1000</p>
Gas reducer		<p>92402 Pcs for blister: 1 Pcs for master: 50 Pcs for europallet: 1000</p>

DISPLAY WINDOW









Display window 75x98		<p>98016 Pcs for blister: 2 Pcs for master: 50 Pcs for europallet: 1000</p>
Dark Display window		<p>98020 Pcs for blister: 2 Pcs for master: 50 Pcs for europallet: 1000</p>
Display window 75x98 (PCS2) + Dark Display window (1PCS)		<p>98023 Pcs for blister: 3 Pcs for master: 50 Pcs for europallet: 1000</p>

TIPS

TIPS M6 x 25 Ø0,6		<p>91203 Pcs for box: 10 Pcs for master: 50 Pcs for europallet: 1000</p>
TIPS M6 x 25 Ø0,8		<p>91214 Pcs for box: 10 Pcs for master: 50 Pcs for europallet: 1000</p>
TIPS M6 x 25 Ø1,0		<p>91227 Pcs for box: 10 Pcs for master: 50 Pcs for europallet: 1000</p>









CONSUMABLES

WELDING ELECTRODES - RUTILE

Welding electrodes Électrodes de soudage Electrodos de soldadura Eletrodos de solda	RUTILE Ø 1,6 L:300mm AWS:E6013 HOBBY SERIES		90050 Pcs for blister: 17 Pcs for master: 50 Pcs for europallet: 1000
	RUTILE Ø 1,6 L:300mm AWS:E6013 HOBBY SERIES		90469 Pcs for blister: 25 Pcs for master: 50 Pcs for europallet: 1000
	RUTILE Ø 2,0 L:300mm AWS:E6013 HOBBY SERIES		90472 Pcs for blister: 25 Pcs for master: 40 Pcs for europallet: 800
	RUTILE Ø 2,0 L:300mm AWS:E6013 HOBBY SERIES		90483 Pcs for blister: 50 Pcs for master: 32 Pcs for europallet: 640
	RUTILE Ø 2,5 L:300mm AWS:E6013 HOBBY SERIES		90052 Pcs for blister: 11 Pcs for master: 40 Pcs for europallet: 800
	RUTILE Ø 2,5 L:300mm AWS:E6013 HOBBY SERIES		90473 Pcs for blister: 25 Pcs for master: 50 Pcs for europallet: 1000
	RUTILE Ø 2,5 L:350mm AWS:E6013 HOBBY SERIES		90484 Pcs for blister: 50 Pcs for master: 16 Pcs for europallet: 320
	RUTILE Ø 3,25 L:350mm AWS:E6013 HOBBY SERIES		90053 Pcs for blister: 9 Pcs for master: 30 Pcs for europallet: 600
	RUTILE Ø 4,0 L:350mm AWS:E6013 HOBBY SERIES		90054 Pcs for blister: 8 Pcs for master: 30 Pcs for europallet: 600





CONSUMABLES

WELDING ELECTRODES - RUTILE



Welding electrodes Électrodes de soudage Electrodo de soldadura Eletrodos de solda	RUTILE Ø 2,0 L:300mm AWS:E6013 ADVANCED SERIES		90641 Pcs for tube: 195 Pcs for master: 4 Pcs for europallet: 80
	RUTILE Ø 2,0 L:300mm AWS:E6013 ADVANCED SERIES		90642 Pcs for tube: 155 Pcs for master: 4 Pcs for europallet: 80
	RUTILE Ø 2,5 L:300mm AWS:E6013 ADVANCED SERIES		90646 Pcs for tube: 121 Pcs for master: 4 Pcs for europallet: 80
	RUTILE Ø 2,5 L:350mm AWS:E6013 ADVANCED SERIES		90647 Pcs for tube: 110 Pcs for master: 4 Pcs for europallet: 80
	RUTILE Ø 3,25 L:350mm AWS:E6013 ADVANCED SERIES		90474 Pcs for tube: 50 Pcs for master: 4 Pcs for europallet: 80
	RUTILE Ø 3,25 L:350mm AWS:E6013 ADVANCED SERIES		90652 Pcs for tube: 70 Pcs for master: 4 Pcs for europallet: 80
	RUTILE Ø 4,0 L:400mm AWS:E6013 ADVANCED SERIES		90656 Pcs for tube: 36 Pcs for master: 4 Pcs for europallet: 80
	RUTILE Ø 4,0 L:350mm AWS:E6013 ADVANCED SERIES		90654 Pcs for tube: 50 Pcs for master: 4 Pcs for europallet: 80

CONSUMABLES

WELDING ELECTRODES - RUTILE







Welding electrodes Électrodes de soudage Electrodos de soldadura Eletrodos de solda	RUTILE Ø 2,0 - Ø 2,5 - Ø 3,25 L:300mm AWS:E6013 PROFESSIONAL SERIES		90791 Pcs for box: 50 - 50 - 30 Pcs for master: 8 Pcs for europallet: 160
	RUTILE Ø 2,0 L:300mm AWS:E6013 PROFESSIONAL SERIES		90732 Pcs for box: 402 Pcs for master: 4 Pcs for europallet: 80
	RUTILE Ø 2,5 L:300mm AWS:E6013 PROFESSIONAL SERIES		90742 Pcs for box: 303 Pcs for master: 4 Pcs for europallet: 80
	RUTILE Ø 2,5 L:350mm AWS:E6013 PROFESSIONAL SERIES		90748 Pcs for box: 230 Pcs for master: 4 Pcs for europallet: 80
	RUTILE Ø 2,5 L:350mm AWS:E6013 PROFESSIONAL SERIES		90747 Pcs for box: 258 Pcs for master: 4 Pcs for europallet: 80
	RUTILE Ø 3,25 L:350mm AWS:E6013 PROFESSIONAL SERIES		90758 Pcs for box: 165 Pcs for master: 4 Pcs for europallet: 80

WELDING ELECTRODES - BASIC



Welding electrodes Électrodes de soudage Electrodos de soldadura Eletrodos de solda	BASIC Ø 2,5 L:350mm AWS:E7018 ADVANCED SERIES		90661 Pcs for tube: 98 Pcs for master: 4 Pcs for europallet: 80
	BASIC Ø 3,25 L:350mm AWS:E7018 ADVANCED SERIES		90671 Pcs for tube: 58 Pcs for master: 4 Pcs for europallet: 80
	BASIC Ø 4,0 L:400mm AWS:E7018 ADVANCED SERIES		90676 Pcs for tube: 30 Pcs for master: 4 Pcs for europallet: 80

CONSUMABLES

WELDING ELECTRODES - STAINLESS STEEL



Welding electrodes Électrodes de soudage Electrodo de soldadura Eletrodos de solda	STAINLESS STEEL Ø 2,5 L:300mm AWS:E308 HOBBY SERIES		90704 Pcs for blister: 10 Pcs for master: 40 Pcs for europallet: 800
	STAINLESS STEEL Ø 3,25 L:350mm AWS:E308 HOBBY SERIES		90714 Pcs for blister: 8 Pcs for master: 30 Pcs for europallet: 600
	STAINLESS STEEL Ø 2,5 L:300mm AWS: E308 ADVANCED SERIES		90701 Pcs for tube: 110 Pcs for master: 4 Pcs for europallet: 80
	STAINLESS STEEL Ø 2,5 L:300mm AWS:E316L ADVANCED SERIES		90702 Pcs for tube: 110 Pcs for master: 4 Pcs for europallet: 80
	STAINLESS STEEL Ø 3,25 L:350mm AWS:E308 ADVANCED SERIES		90711 Pcs for tube: 57 Pcs for master: 4 Pcs for europallet: 80
	STAINLESS STEEL Ø 2,5 L:350mm AWS:E316L ADVANCED SERIES		90712 Pcs for tube: 57 Pcs for master: 4 Pcs for europallet: 80

WELDING ELECTRODES - CAST IRON







Welding electrodes Électrodes de soudage Electrodo de soldadura Eletrodos de solda	CAST IRON Ø 2,5 L:300mm AWS:A5.15 HOBBY SERIES		90028 Pcs for blister: 12 Pcs for master: 40 Pcs for europallet: 800
	CAST IRON Ø 3,25 L:350mm AWS:A5.15 HOBBY SERIES		90029 Pcs for blister: 9 Pcs for master: 40 Pcs for europallet: 800

CONSUMABLES

WELDING ELECTRODES - CELLULOSIC









Welding electrodes Électrodes de soudage Electrodos de soldadura Eletrodos de solda	CELLULOSIC Ø 2,5 L:350mm AWS:E6010 ADVANCED SERIES		90681 Pcs for tube: 142 Pcs for master: 4 Pcs for europallet: 80
	CELLULOSIC Ø 3,25 L:350mm AWS:E6010 ADVANCED SERIES		90691 Pcs for tube: 77 Pcs for master: 4 Pcs for europallet: 80
	CELLULOSIC Ø 4,0 L:350mm AWS:E6010 ADVANCED SERIES		90696 Pcs for tube: 50 Pcs for master: 4 Pcs for europallet: 80

FILLER RODS TIG

Filler rods TIG Metal d'apport Material de aporte Haste de enchimento	INOX FILLER RODS TIG Ø 1,6 L:330mm AWS: ER308L HOBBY SERIES		90060 Pcs for blister: 60 Pcs for master: 40 Pcs for europallet: 800
	INOX FILLER RODS TIG Ø 2,0 L:330mm AWS: ER308L HOBBY SERIES		90061 Pcs for blister: 40 Pcs for master: 40 Pcs for europallet: 800
	SG2 FILLER RODS TIG Ø 1,6 L:330mm AWS: ER706S-6 HOBBY SERIES		90062 Pcs for blister: 60 Pcs for master: 40 Pcs for europallet: 800
	SG2 FILLER RODS TIG Ø 2,0 L:330mm AWS: ER706S-6 HOBBY SERIES		90063 Pcs for blister: 40 Pcs for master: 40 Pcs for europallet: 800
	INOX FILLER RODS TIG Ø 1,6 L:330mm AWS: ER316L HOBBY SERIES		90064 Pcs for blister: 60 Pcs for master: 40 Pcs for europallet: 800
	INOX FILLER RODS TIG Ø 2,0 L:330mm AWS: ER316L HOBBY SERIES		90065 Pcs for blister: 40 Pcs for master: 40 Pcs for europallet: 800

CONSUMABLES

WELDING WIRE

Welding wire Fil de soudure Alambre de soldadura Fio de solda	SG2 Ø 0,6 L:100mm Kg: 1,0		90112 Pcs for blister: 1 Pcs for master: 30 Pcs for europallet: 600
	SG2 Ø 0,6 L:200mm Kg: 5		90120 Pcs for box: 1 Pcs for master: 4 Pcs for europallet: 200
	SG2 Ø 0,8 L:100mm Kg: 1,0		90114 Pcs for blister: 1 Pcs for master: 30 Pcs for europallet: 600
	SG2 Ø 0,8 L:200mm Kg: 5		90122 Pcs for box: 1 Pcs for master: 4 Pcs for europallet: 200
	INOX Ø 0,8 L:100mm Kg: 1,0		90116 Pcs for box: 1 Pcs for master: 30 Pcs for europallet: 600
	FLUX Ø 0,9 L:100mm Kg: 0,2		82421 Pcs for box: 1 Pcs for master: 30 Pcs for europallet: 600
	FLUX Ø 0,9 L:100mm Kg: 1,0		90118 Pcs for box: 1 Pcs for master: 30 Pcs for europallet: 600
	FLUX Ø 0,9 L:200mm Kg: 4,5		90126 Pcs for box: 1 Pcs for master: 4 Pcs for europallet: 200



TIG TORCH 17V - 4 MT - D25

Cod. 98017

EN60974-7

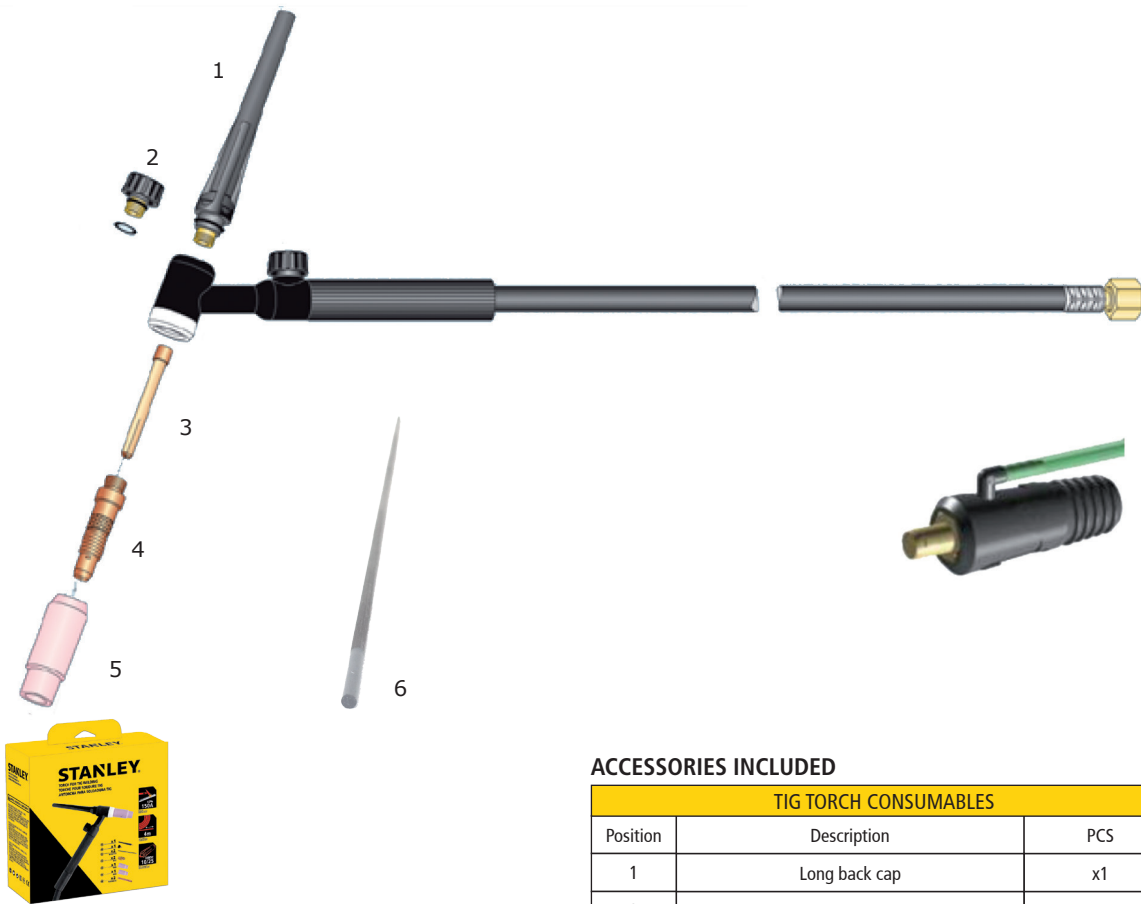

Technical specifications
Duty 35% DC: 140A
Duty 35% AC: 125A
Electrodes size: 0.5-2.4mm

ACCESSORIES INCLUDED

TIG TORCH CONSUMABLES		
Position	Description	PCS
1	Long back cap	x1
2	Short back cap	x1
3	Collet Ø1,6x50mm	x2
4	Collet body Ø1,6mm	x2
5	Allumina cup GR5	x1
	Allumina cup GR6	x1
6	Tungsten electrodes Ø1,6 - length:150mm	x2

TIG TORCH CONSUMABLES KIT

Long back cap - 1pcs
Short back cap - 1pcs
Collet Ø1,6x50mm - 1 pcs
Collet body Ø1,6mm - 1 pcs
Allumina cup GR5 - 1 pcs
Allumina cup GR6 - 1pcs
Tungsten electrodes Ø1,6 length:150mm - 1 pcs

96052
kit compatible with
TIG TORCH 17V
and
TIG TORCH HF 26

Pcs for master: 40
Pcs for europallet: 80

TIG TORCH KIT

TIG TORCH 17V - 4 MT + DINSE ADAPTER 35-50



96011
Pcs for master: 4
Pcs for europallet: 80

TIG TORCH 17V - 4 MT + GAS REDUCER + GAS TUBE



98021
Pcs for master: 4
Pcs for europallet: 80

TIG TORCH HF 26 - 4 MT - D35

Cod. 96022

EN60974-7

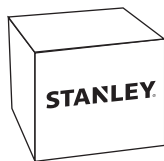
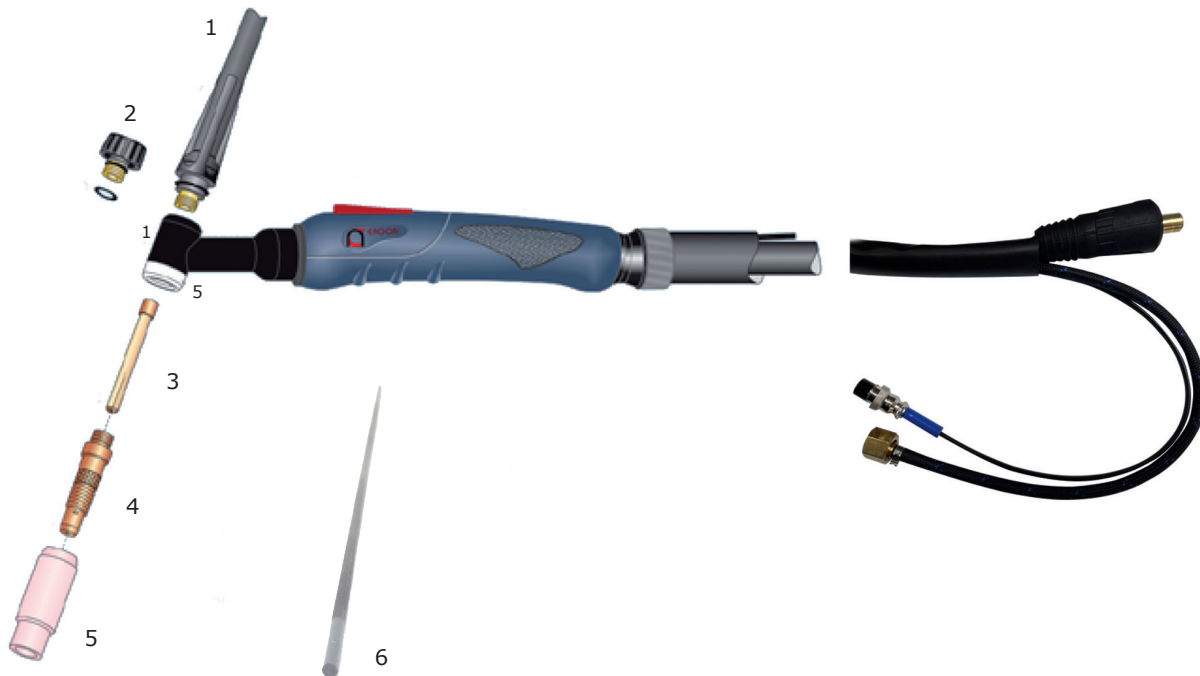

Technical specifications

Duty 35% DC: 180A
 Duty 35% AC: 150A
 Electrodes size:
 0.5-3.2mm

ACCESSORIES INCLUDED

TIG TORCH CONSUMABLES		
Position	Description	PCS
1	Long back cap	x1
2	Short back cap	x1
3	Collet Ø1,6	x1
	Collet Ø2,4	x1
	Collet Ø3,2	x1
4	Collet body Ø1,6mm	x1
	Collet body Ø2,4mm	x1
	Collet body Ø3,2mm	x1
5	Allumina cup GR5	x1
	Allumina cup GR8	x1
6	Tungsten electrodes Ø1,6 - length:150mm	x1
	Tungsten electrodes Ø2,4 length:150mm	x1
	Tungsten electrodes Ø3,2 length:150mm	x1

TIG TORCH CONSUMABLES KIT

Long back cap - 1 pcs
 Short back cap - 1 pcs
 Collet Ø1,6x50mm - 1 pcs
 Collet body Ø1,6mm - 1 pcs
 Allumina cup GR5 - 1 pcs
 Allumina cup GR6 - 1 pcs
 Tungsten electrodes Ø1,6 length:150mm - 1 pcs

Long back cap - 1 pcs
 Short back cap - 1 pcs
 Collet Ø1,6 - 1 pcs
 Collet Ø2,4 - 1 pcs
 Collet Ø3,2 - 1 pcs
 Collet body Ø1,6mm - 1 pcs
 Collet body Ø2,4mm - 1 pcs
 Collet body Ø3,2mm - 1 pcs

Allumina cup GR5 - 1 pcs
 Allumina cup GR8 - 1 pcs
 Tungsten electrodes:
 - Ø1,6 length:150mm - 1 pcs
 - Ø2,4 length:150mm - 1 pcs
 - Ø3,2 length:150mm - 1 pcs

96052
 kit compatible with
TIG TORCH 17V
 and
TIG TORCH HF 26
 Pcs for master: 40
 Pcs for europallet: 800

96056
 kit compatible with
TIG TORCH HF 26
 Pcs for master: 40
 Pcs for europallet: 800

